

SPS 200

SPS process pump

Features and benefits

- Low shear transfer pump, with flow up to 7800 L/h at pressures up to 10 bar
- Superior viscous handling
- Consistent flow with high suction capability up to 0.85 bar
- Flexible configuration of housing, nozzle type, size orientation, drive and baseplate
- Hygienic CIP and SIP capability
- FDA and EC 1935/2004 compliance
- Operating temperatures up to 180 °C
- 20-year guarantee on front cover and pump housing



Performance curves

These performance curves show the theoretical flow without consideration of slip

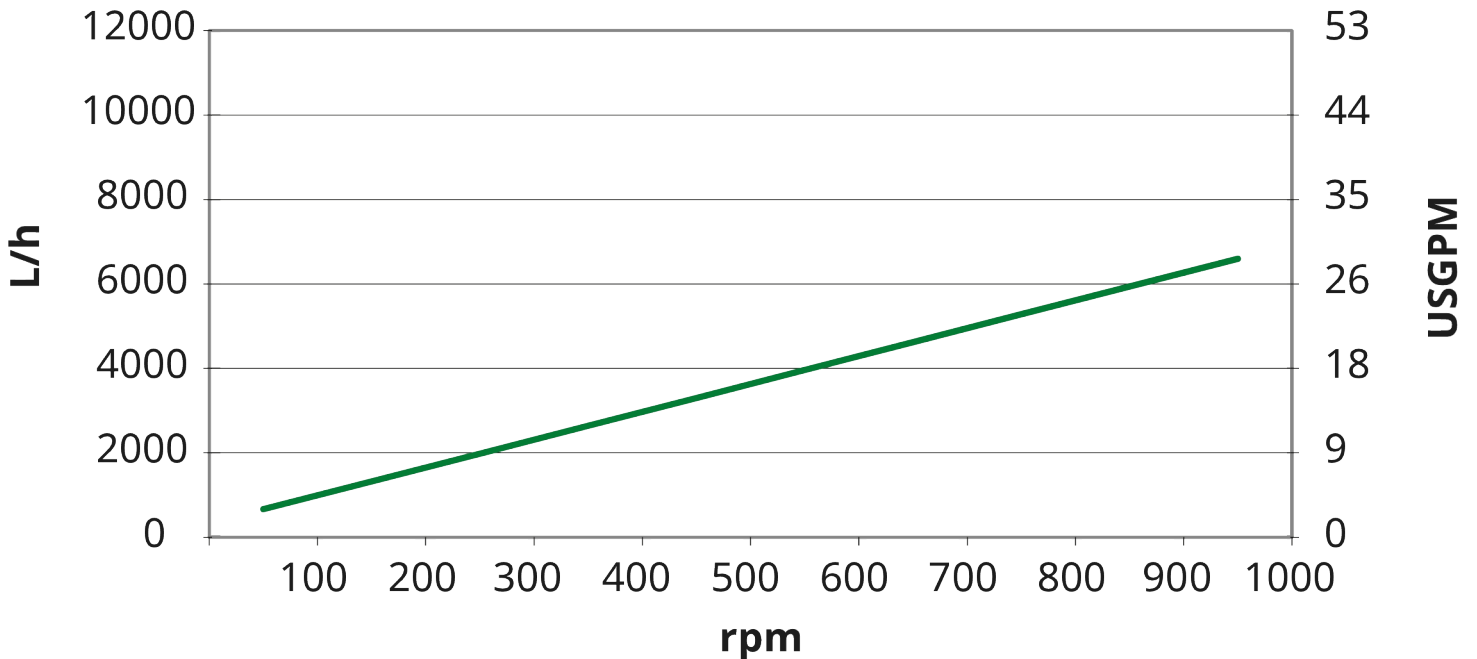

Technical specifications

	SPS 200
Volume per revolution	0.034 USG (0.13 l)
Max. particle size	0.79 in (20 mm)
Suction pressure	85% of a vacuum
Max. operating pressure	145 psi (10 bar)
Operating temperature	-4 °F to 356 °F (-20 °C to 180 °C)
Standards	ATEX
Certification and compliance	EC 1935/2004, FDA
Port orientation	Various options to meet your requirements
Port type	Flange, Milk fitting, RJT, SMS, TC
Shaft diameter	1.1 in (28 mm)
Shaft height	3.74 in (95 mm)

Materials of construction

	SPS 200
Housing	Stainless steel 1.4404, Stainless steel 316L
Bearing frame	Stainless steel 1.4301, Stainless steel 304
Rotor	Stainless steel 1.4404, Stainless steel 316L
Gate and liners	Polyamide
Seals/gaskets	EPDM, FFKM, FKM, NBR, PTFE

SPS 200 dimensions

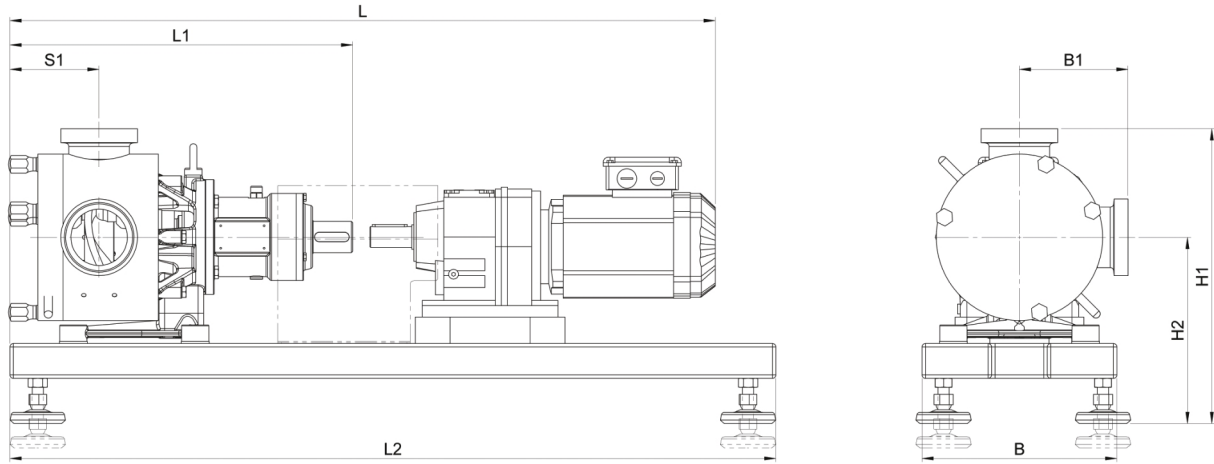

Model	L		L1		L2		S1		B		B1		H1		H2									
	min.	max.							min.	max.	min.	max.	min.	max.	min.	max.								
	mm	inch	mm	inch	mm	inch	mm	inch	mm	inch	mm	inch	mm	inch	mm	inch	mm	inch						
SPS 200	740	29.1	960	37.8	345	13.6	800	31.5	95	3.7	210	8.3	106	4.2	137	5.4	314	12.4	344	13.5	208	8.2	238	9.4

Disclaimer: All flow rates shown were obtained pumping water at 20 °C (68 °F) with zero suction and delivery heads. Disclaimer: The information contained in this document is believed to be correct but Watson-Marlow Limited accepts no liability for any errors it contains and reserves the right to alter specifications without notice. Watson-Marlow, MasoSine, Qdos, ReNu, LoadSure, Bioprene, Pumpsil and Marprene are trademarks of Watson-Marlow Limited. STA-PURE PFL® and STA-PURE PCS® are registered trademarks of W.L Gore & Associates Inc. Please state the product code when ordering pumps and tubing.



wmfts.com/global
28 October 2025