



PTFE lined, flexible hoses for Biotech and Pharmaceutical



Highly flexible
Kink-resistant
24 month guarantee
Up to 80mm bore
Lengths up to 30m



THE WORLD'S LEADING MANUFACTURER OF PTFE LINED FLEXIBLE HOSE

For more than 40 years, we have been producing the most technically advanced range of PTFE lined flexible hose products in the world.

From our factories in the UK and USA, we design, develop and manufacture our hoses from raw materials to finished products. This comprehensive approach gives us an unrivaled ability to meet specific needs, whatever your application.

Our dedication to developing quality products and becoming a trusted partner, has meant our biotechnology and pharmaceutical customers have standardized on our hose products as the most reliable choice in their manufacturing plants.



UNIQUE LINER DESIGN

LINED AND NON-LINED END FITTINGS



Aflex hose products are created through a combination of expert engineering and material knowledge.

Lined with polytetrafluorethylene (PTFE), our hoses offer excellent chemical resistance. Their structure provides a smooth bore to ensure clean, fast performance, resistant to high pressures and temperatures up to 260C.

PTFE is proven to outperform rubber, silicone and PVC in similar applications. Cleanability and steam resistance ensures compliance to the highest hygiene standards. Hoses are constructed without the use of adhesives, eliminating the risk of contamination.

- Highly flexible and kink-resistant
- Available with either natural or anti-static patented PTFE liner
- Industry leading twenty four month guarantee
- No adhesives in hose manufacture eliminate the risk of contamination
- Up to 80mm bore and hose lengths of up to 30 meters

24
24 Month
MANUFACTURER'S
GUARANTEE

-0.9 Bar
VACUUM
RESISTANCE
All sizes

PTFE
will outperform
RUBBER SILICONE PVC

Bioflex Ultra

Bioflex Ultra® hose is chemically inert, making it the perfect choice for clean, fast flow of high purity fluids.

- Choose from five external hose cover options (See page 10)
- Suitable for CIP and SIP cleaning. COP soaking and extensive autoclave sterilizing (unlined end-fittings)
- PTFE lined end-fittings ensure only PTFE comes into contact with process fluids
- Resistant to temperatures from -73C to 260C
- -0.9bar vacuum resistant

EN 16643:2016
USP CLASS VI
OHSAS 18001:2015
USP 661
EU 10/2011
EC 1935/2004

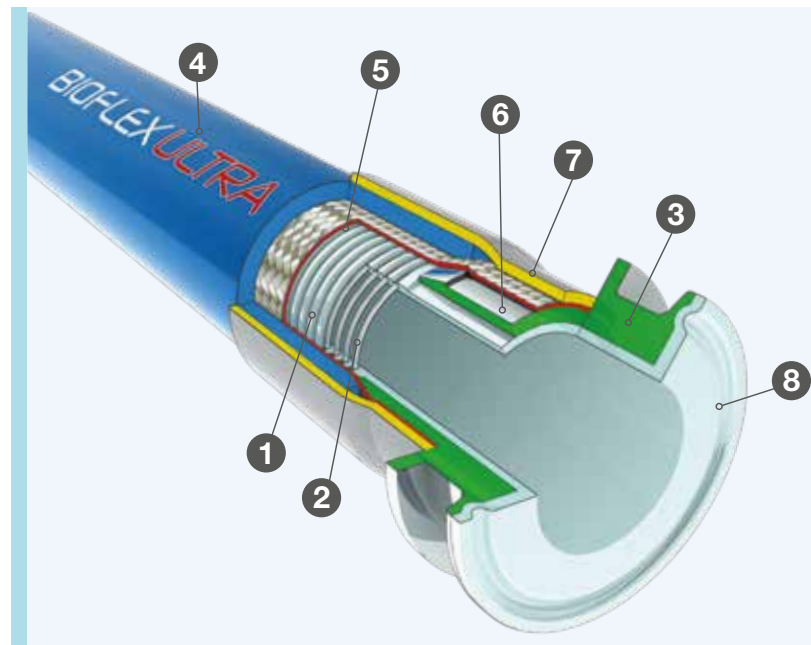

Aflex hose unique PTFE liner

The patented design of the PTFE liner used in Bioflex Ultra, Pharmaline N and X allows the liner to expand around the outside and compress around the inside of a bend. This helps to retain a smooth circular bore throughout the hose, without distortion.

- General purpose or anti-static options
- No entrapment zones
- Minimal turbulence means a faster flow rate
- Excellent internal cleanability
- Longer service life

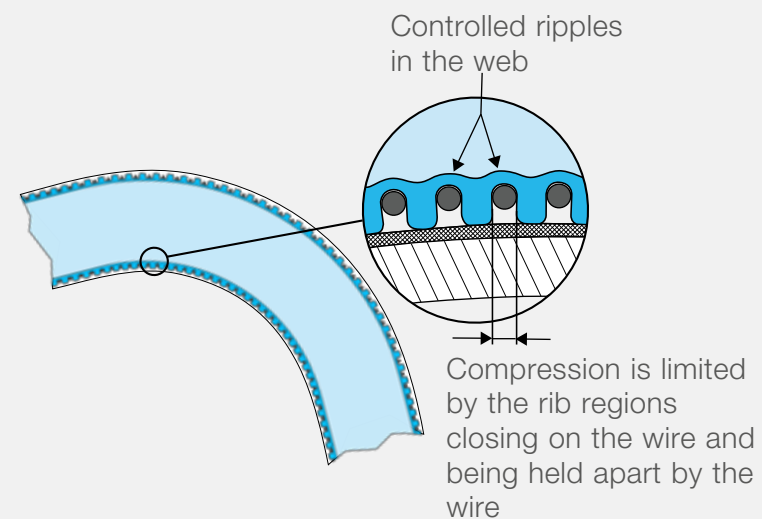

Pharmaline N and X

Pharmaline® N and X hoses are designed to replace conventional silicone rubber hoses in biotech and pharmaceutical fluid transfer applications for improved compatibility and cleanability.

- Smooth, platinum-cured silicone cover
- Suitable for CIP and SIP cleaning. COP soaking and extensive autoclave sterilizing
- Available in hygienic 316 stainless steel
- Resistant to temperatures from -73C to 204C
- -0.9bar vacuum resistant

EN 16643:2016
USP CLASS VI
USP 661
EU 10/2011
EC 1935/2004

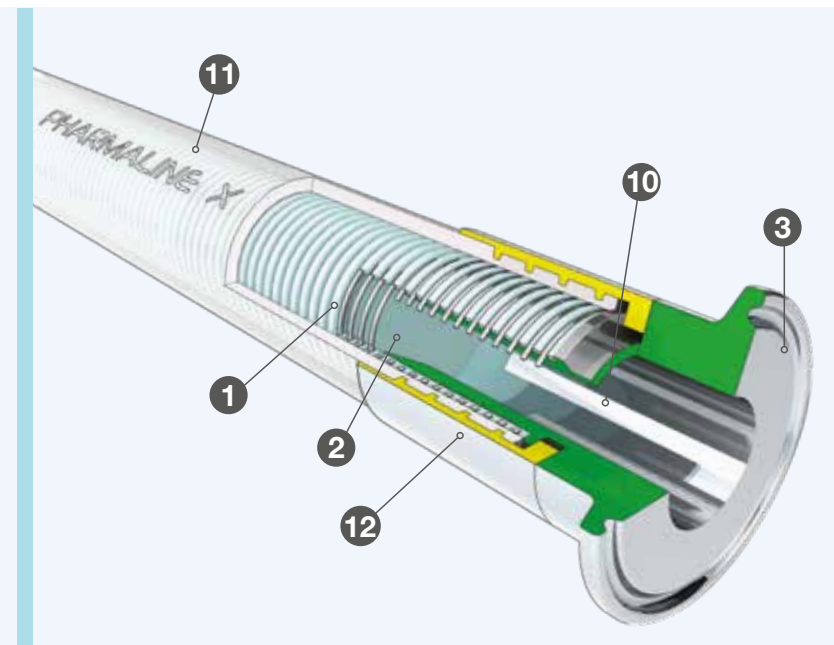
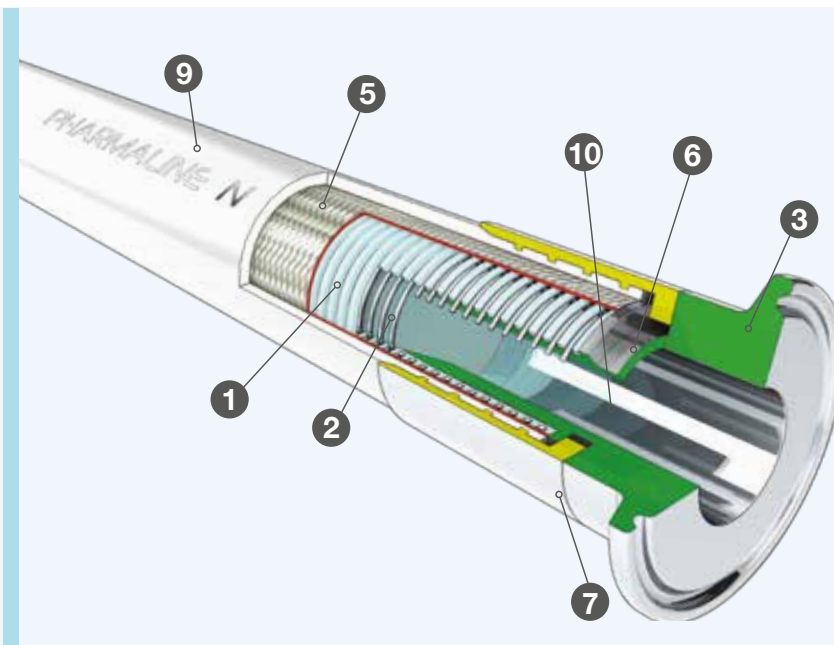

- | | | |
|---|--|---|
| 1. PTFE liner tube, smooth bore inside, convoluted outside | 6. 316 stainless steel spigot | 10. Polished hygienic tail supports the bore of the liner |
| 2. 316 stainless steel helical wire reinforcement | 7. Ferrule, crimped to secure braid to spigot | 11. Platinum cured transparent silicone rubber cover (marked in accordance with EN 16643) |
| 3. Sanitary Tri-clamp Insert | 8. PTFE liner tube extended through the end fitting, then flared out and hot-formed on the sealing face (optional) | 12. Ferrule crimped direct onto rubber cover |
| 4. EPDM rubber cover (optional, other cover material available see page 10) | 9. Platinum-cured white silicone rubber cover (Marked in accordance with EN 16643) | |
| 5. 316 stainless steel braid | | |

Applications

Eliminating risk of bacteria in plasma transfer

A leading supplier of therapeutic proteins and diagnostic products were having problems with hoses used in blood plasma transfer. The hoses were prone to internal damage which raised the risk of bacteria. Changing to Pharmaline N PTFE hose eliminated this problem. Pharmaline hoses carry a 24 month guarantee and all required certification including USP Class VI.

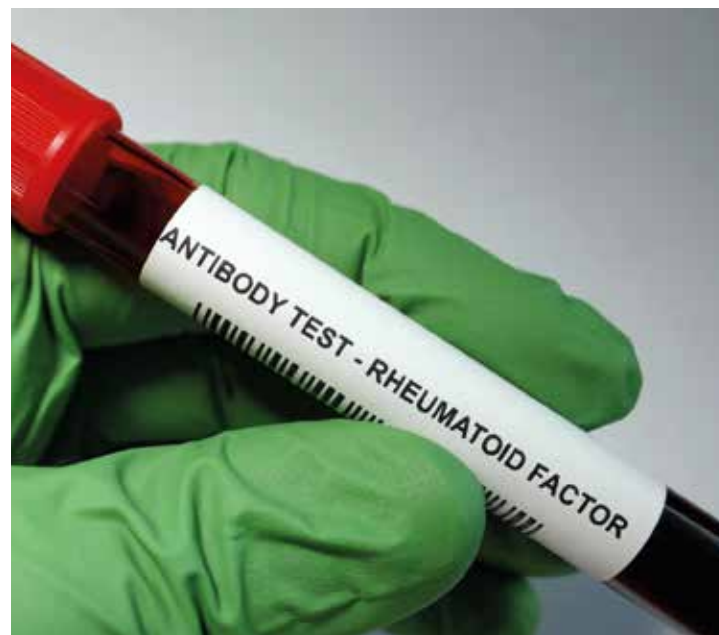

Overcoming leaching into finished product

A French pharmaceutical company using silicone hoses in a cough syrup filling process suffered leaching of extractables. The company changed to Bioflex Ultra with its non-absorbent PTFE liner and eliminated the risk of contamination to fluids.



Drug preparation in cleanroom environments

PTFE lined Pharmaline N meets the demand for chemical resistance and exceeds performance of silicone hoses in repeated CIP cleaning in pharmaceutical processes. Pharmaline N plays a vital role in the manufacture and packaging of asthma inhalation spray liquid. In particular, hoses are used on a relief line and activated when the pressure becomes too great within the pipework.



Reducing time and costs for tanker offloading

Tanker offload time can be critical. Pharmaceutical companies pay transport companies for the time tankers are onsite offloading chemicals. One pharmaceutical company switched to Aflex hoses and cut the offloading time of fine chemicals from six to just two hours. Aflex hoses were able to offer higher flow rates of chemicals and their superior flexibility made it easier for operators to connect the hoses in restricted spaces.



Technical specifications

Bioflex Ultra

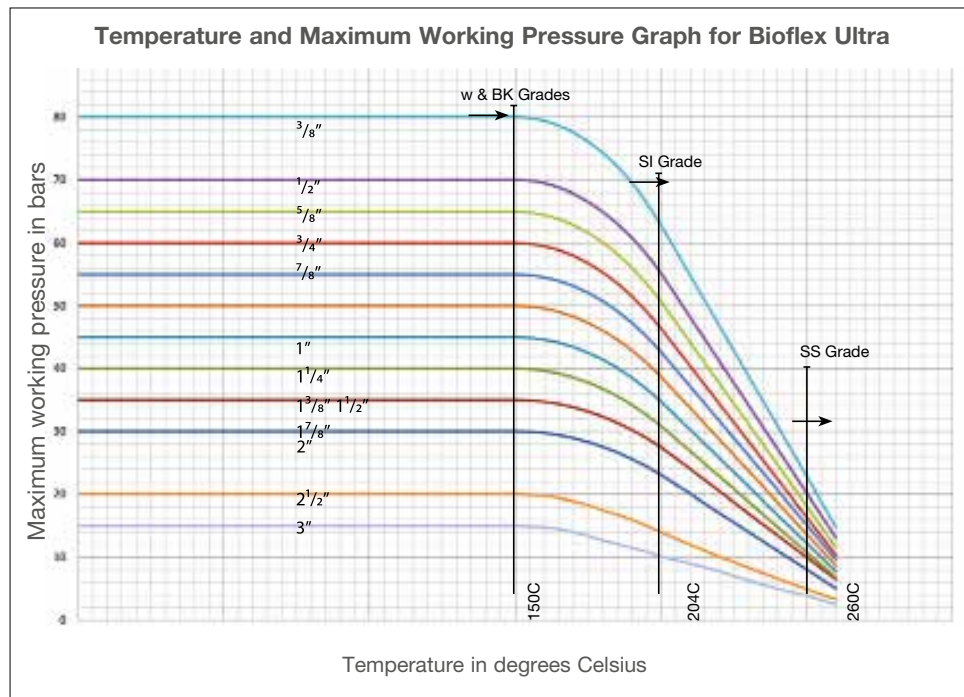

Hose bore size range

3/8"–3"

Hose lengths

30m (up to 2" bore size)
18m (up to 2 1/2" bore size)
15m (up to 3" bore size)

Temperature limits

SS braided hose
-73C–260C

EPDM rubber covered hose
-40C–150C

Silicone rubber covered hose
-73C–204C

Polypropylene braided hose
-30C–100C

Working pressure ranges

SS braided hose and EPDM rubber covered hose

80bar for 3/8" bore size
15bar or 3" bore size

Vacuum limitations

Usable at vacuum to -0.9bar for all sizes up to 200C

100C for tube only grade (TO)

Pharmaline N and X

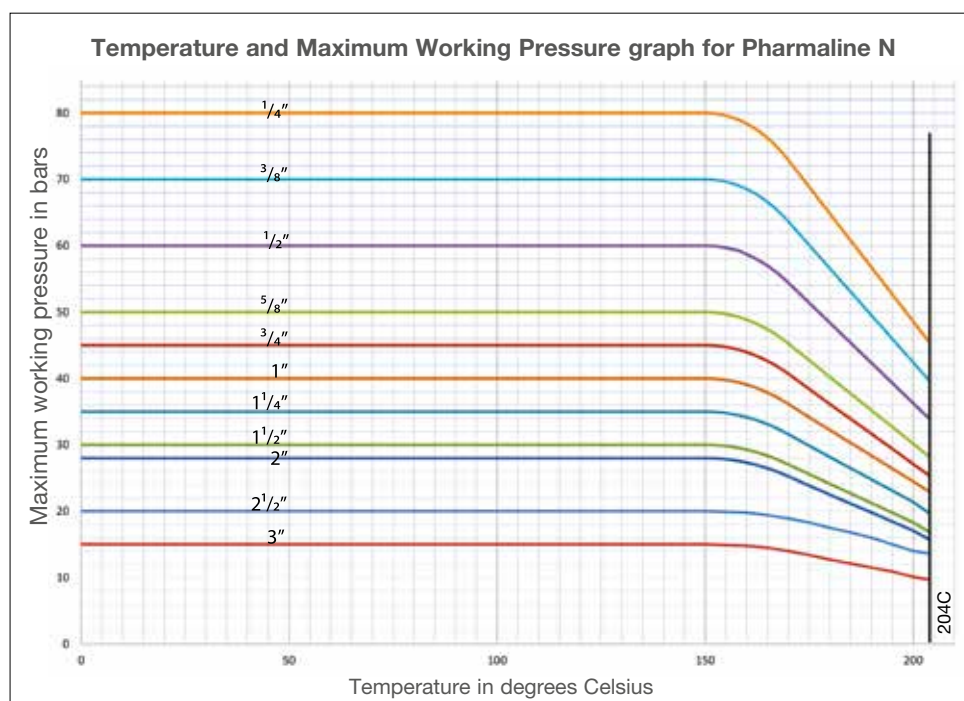

Hose bore size range

Pharmaline N 1/4"–3"

Pharmaline X 1/4"–2"

Hose lengths

Pharmaline N
30m (up to 2" bore size)
18m (up to 2 1/2" bore size)
15m (up to 3" bore size)

Pharmaline X
20m (up to 1" bore size)
6m (up to 2" bore size)

Temperature limits

-73C–204C

Working pressure ranges

Pharmaline N
80bar for 1/4" to 15bar for 3"

Pharmaline X
7.5bar for 1/4" to 2bar for 2"

Vacuum limitations

Usable at vacuum to -0.9bar for all sizes up to 150C

Hose liners



GP - general purpose liner

GP 'General Purpose' hoses are for applications where fluids or gases being conveyed do not generate a risk of static charge development.



AS - anti-static PTFE liner

AS hoses are for use where the risk of an electrostatic charge build-up on the inside surface of the PTFE tube may then discharge through the tube wall.

Labelling



Laser etched as standard for ultimately traceability

All Bioflex Ultra, Pharmaline N and X hose assemblies are labelled with the following information:

Manufacturer's name (Aflex Hose Ltd)
Hose type, size and grade
EN16643 and year of standard publication
EN16643 Electrical property grade
Max. working pressure and test pressure

Working temperature range*
Unique serial number
Month and year of manufacture
Aflex Telephone number
CE Mark (if applicable)

**Note any restrictions on working pressure resulting from elevated temperatures.*

This information is normally laser-etched onto a ferrule.

In some cases the information may be etched onto a stainless steel ring, or a thin stainless steel plate which is clamped to the hose.



Streamline tagging

A label and/or colour code is placed around the silicone cover of the hose and then encapsulated by a transparent silicone that is formed into a thin streamlined cover.

Note: 1/4" size, colour code only, no text.

Bioflex Ultra—Streamline tagging is available for Silicone rubber covered grades with stainless steel braid.



Color coding

A colored PTFE spiral strip is wound on to the hose.



It can be left loose, or it can be encapsulated under a transparent, heat-shrunk polyolefin sleeve.

Technical specifications

Hose braiding

	Bioflex Ultra	Pharmaline N	Pharmaline X
 <p>White platinum-cured silicone rubber cover</p> <ul style="list-style-type: none"> Marked in accordance with EN 16643 		•	
 <p>Platinum-cured transparent silicone rubber cover</p> <ul style="list-style-type: none"> Marked in accordance with EN 16643 			•
 <p>SI - Transparent Platinum-cured silicone rubber cover</p> <ul style="list-style-type: none"> Temperature range -73C–204C Semi-transparent, allowing visual monitoring of the braid USP Class VI 	•		
 <p>TO - Tube only (no braid)</p> <ul style="list-style-type: none"> Vacuum resistant to -0.9bar up to 100C 	•		
 <p>SS - Stainless steel braid</p> <ul style="list-style-type: none"> High tensile AISI 316 stainless steel wire Maximum pressure resistance and external protection 	•		
 <p>PB - Polypropylene braid</p> <ul style="list-style-type: none"> Temperature range -30C–100C Two strands of Monel wire earthing strips ensure electrical continuity between end fittings 	•		
 <p>RC - Blue EPDM rubber covered</p> <ul style="list-style-type: none"> USP Class VI Stands up to rough treatment and severe external abrasion External surface is smooth and easy to clean Temperature range -40C–150C 	•		
 <p>BK - Black EPDM rubber covered</p> <ul style="list-style-type: none"> Fireproof to BS5173 Section 103.13 Part 6.2 and 6.3. EN 16643 flame resistant Anti-static in accordance with specification EN 16643 	•		
 <p>RC-300 - Rubber covered 300mm long end protection</p> <ul style="list-style-type: none"> For applications where excessive flexing of the hose at the end fitting occurs, it is sometimes necessary to 'stiffen' the hose in this area, to prevent kinking 	•		
 <p>SG - Safeguard protection sleeve</p> <ul style="list-style-type: none"> Lightweight, black, HDPE (High Density Polyethylene) To protect the hose against external abrasion and mechanical damage. Temperature range -40C–110C Internal fluid temperatures up to 140C 	•		
 <p>SR - Scuff rings</p> <ul style="list-style-type: none"> For medium duty applications where the hose requires some protection against abrasion when dragged over the ground, but where a full rubber cover would be too heavy. Also for polypropylene braided hose, which cannot be rubber covered 	•		
 <p>PC - Protection coil</p> <ul style="list-style-type: none"> For applications where the hose requires protection against abrasion when dragged over the ground, but where any rubber reinforcement is not permissible due to temperature, chemicals or other factors 	•		

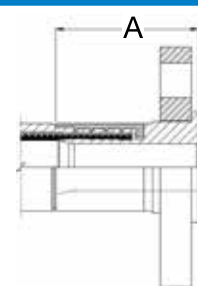
End fittings

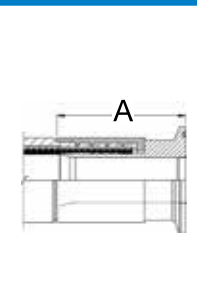
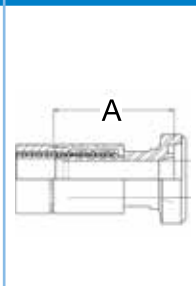
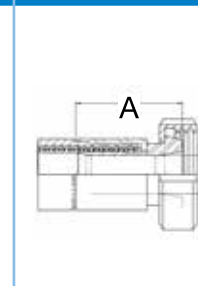
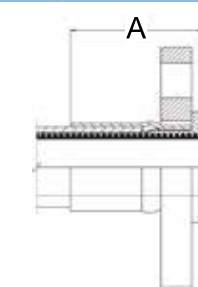
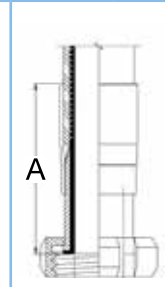
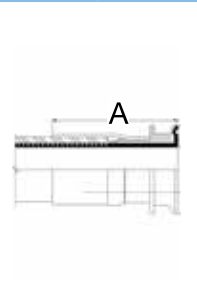
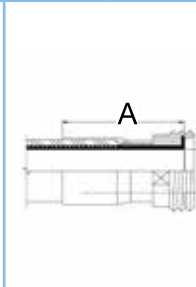
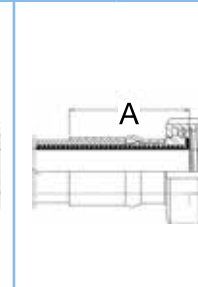
	Flanges		SMS Female		NPT or BSPT fixed Male		Tri-clamp fittings		DIN 11851 Male		DIN 11851 Female	
	A		A		A		A		A		A	
Non-lined fittings												
Lined fittings												
Size	Non-lined		Lined		Non-lined	Lined	Non-lined	Lined	Non-lined	Lined	Non-lined	Lined
	ASA 150	PN 10/16	ASA 150	PN 10/16								
¼									33			
⅜									42			
½	43	46	57	58			61		44		46	58
⅝											77	
¾	47	54	48	49			68		50		52	62
*⅞											65	
1	60	62	61	63		86	78		58	65	68	76
1¼	68	69	57	59		86	91				63	70
*1½											72	
1½	70	74	60	62		94	97		67	80	72	72
*1¾											84	
2	81	89	69	74		104	116		78	91	82	88
2½	94	92	124	124		162	135		71	135	82	150
3	95	95	131	131		174	137		80	142	82	162

All dimensions in mm

* ⅞, 1½ and 1¾ hose sizes are only suitable for use with PTFE sanitary clamp (or Triclover) and PTFE lined I-line end fittings.





Watson-Marlow Fluid Technology Group
Watson-Marlow Fluid Technology Group supports its customers locally through an extensive global network of direct sales operations and distributors

wmftg.com/global

