

INSTRUCTION HANDBOOK

PD22I

PD22P



(foto examples; exact model may vary)

1 TABLE OF CONTENTS

1	TABLE OF CONTENTS.....	2
2	PD22 I / PD22 P important notice	3
3	Caution.....	4
4	General information	5
4.1	Unpacking and inspection.....	5
4.2	The peristaltic principle	5
4.3	Installation	6
4.3.1	PD22I Installation	6
4.3.2	PD22P Installation	7
4.4	Addressing of filling station	8
5	Control.....	9
5.1	Dispenser head	9
6	Dispensing with PD22.....	10
6.1	Vessel Placement.....	10
6.2	Tube size.....	11
6.3	Nature of fill media.....	12
6.4	Priming tubes	12
6.5	Drip.....	12
6.6	Hard Feed	12
7	Tube assembly	13
7.1	Assembly of Y-connectors	13
7.2	Placing tubes in the pump head.....	13
8	Programming.....	15
8.1	Programming principle.....	15
8.2	PD22 parameters	15
9	Cleaning and maintenance	16
9.1	Daily cleaning	16
9.2	Sterilization.....	16
9.3	Maintenance.....	16
10	Interface and change of voltage.....	17
10.1	PD22 I Interface.....	17
10.2	PD22 P Interface	18
10.3	Connecting multiple PD22P's to Flexnet.....	19
10.4	Change of voltage	19
11	Declaration of conformity	20

2 PD22 I / PD22 P important notice

There are 2 versions of the PD22.

- The PD22 I (individual)
- The PD22 P (Panel mount)

They share the same functions and programming routines.

The main difference is that the PD22 I has its own cabinet, and the PD22 P is mounted through a panel.

Besides this there are differences in the way the "I" and "P" version are connected to power supply and to the external pump controller (MC12).

In the last sections of the manual we will describe the connections and interfaces.

For the remainder of this manual the PD22 will be designated as follows:

PD22: for general descriptions covering both versions.

PD22 I: for descriptions specific to the "I" version.

PD22 P: for descriptions specific to the "P" version.

3 Caution

This manual should be read before using the PD22.

Explanations to the pictograms:

Warning against touching/Warning against opening:



Warning against high voltage:



When operating the PD22, make sure that the dispenser head is closed.

The mains switch is used for emergency stopping.

The PD22 should only be used for dosing and filling of liquid fluids.

The PD22 must be placed on a stable bed plate and in such a way, that it is not exposed to great humidity, high temperatures or other abnormal operating-environments. It is not to be used in explosion hazardous environments.

It is prohibited to maintain or clean the PD22, when it is connected to the power supply.

It is prohibited for unauthorised personnel to open the cover of the PD22's electrical parts.

Always remember that the PD22 must be earthed by way of the switch.

The pump must not run dry.

The pump needs a filling nozzle with cut off valve.

4 General information

4.1 *Unpacking and inspection*

PD22 is a peristaltic filler in the Flexicon Multi Filling System (FMFS). The PD22 cannot do fillings by itself, but must be connected to Flexicons control unit, the MC12.

Please check that all ordered items have been received and that no items were damaged during transport. In case of any defects or omissions, please contact WM Flexicon A/S or your supplier immediately.

When ordering spare parts or accessories for the PD22, please state the serial number stamped. The serial number is stamped on the label on the bottom of the PD22.

Please check that the connected mains plug is of the correct type with the correct earthed switch. If this is not the case, the correct type of plug must be mounted with the following connections.

Yellow-green:	earth
Blue:	neutral
Brown:	line

ALWAYS REMEMBER that this machine must be earthed.

4.2 *The peristaltic principle*

PD22 operates with a peristaltic dispenser head (tube pump), where the liquid only comes into contact with the flexible tube, the tube connections and the filling needle. The tubes are usually made of silicone, but other materials can also be used.

The dispenser head is designed in such a way that sterilized tubes can be mounted in the head without affecting the sterility.

WM Flexicon's tubes fulfil biopharma requirements.

The tubes are delivered in sealed packages and are provided with a batch number which makes it possible to trace the tubes all the way back to the raw material source.

For this reason the PD22 is especially suited for aseptic applications and for preventing cross-contamination among different products.

The dispenser head is self-priming, and the dispenser head itself can stand to be run dry.

It is recommended not to let the dispenser head be run dry for a long period WITH MOUNTED TUBES, since this will lead to particle release.

A peristaltic dispenser head is not suitable for viscous products.

4.3 Installation

4.3.1 PD22I Installation

PD22I must be placed on a stable bedplate, and all electrical connections are on its rear.

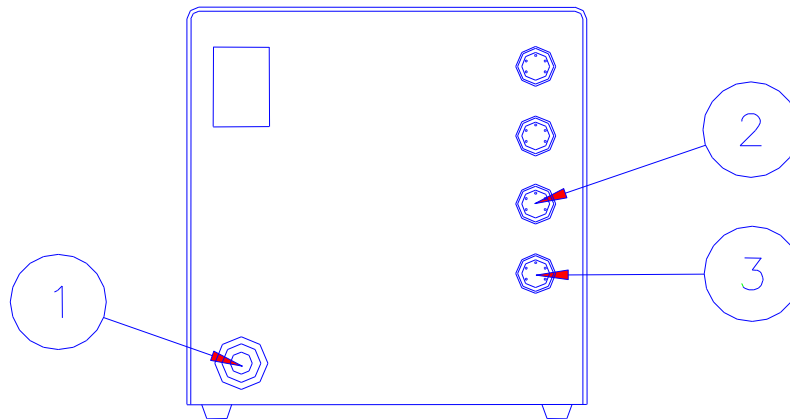

Fig. 4.1

The cable with plug (1) is connected to an earthed switch.

The communication cable from MC12 (type 3) comes fitted with two 4-pin DIN plugs. One is connected to the "net 1" socket (2) on the PD22I, and the other plug is connected to the "net" socket on MC12.

The terminator supplied with MC12 (4-pin blind DIN plug) is connected to the "net 2" (3) socket on PD22I.

Should the system be operating more than one PD22I, the "net 2" socket (3) is to be connected to the "net 1" socket (2) on the next PD22I by a communication cable (type 3). The terminator is connected to the last PD22I on the line.

Address "1" is the factory setting of PD22I. In case you want to change this setting, please consult section 4.4 in this manual.

PD22I is now ready to be switched on and to be programmed from the MC12.

4.3.2 PD22P Installation

PD22P must be placed either in frame delivered or otherwise in a suspension frame.

All electrical connections are on the rear side.

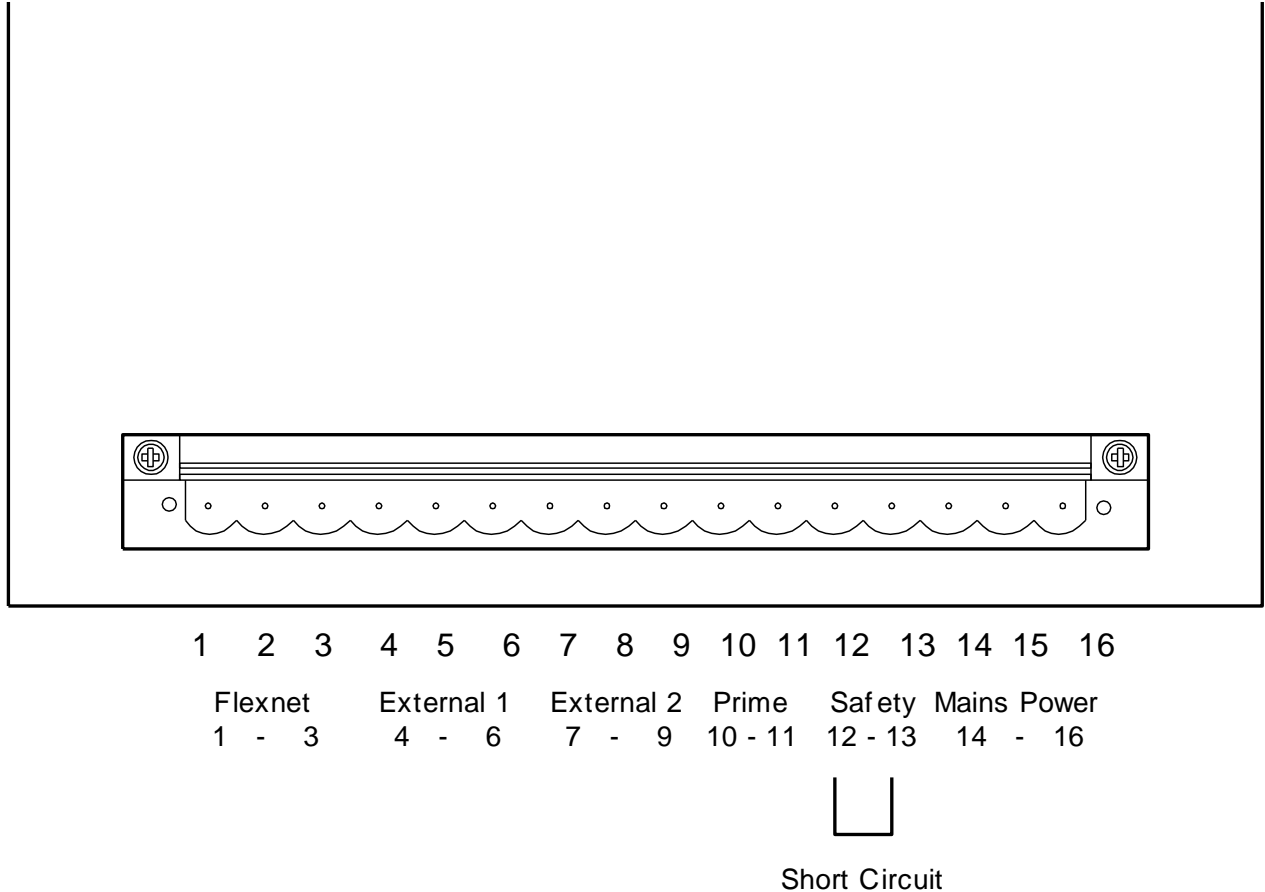

Fig. 4.2

The power supply is mounted with 0 in pin 14, earth in pin 15 and phase in pin 16.

The communication cable from MC12P is mounted in pin 1-3.

Should the system be operating more than one PD22P, the communication lines are connected in parallel in pin 1-3 in all units.

Address "1" is the factory setting of PD22P. In case you want to change this setting, please consult section 4.4 in this manual.

PD22P is now ready to be switched on and to be programmed from the MC12P.

4.4 Addressing of filling station

Address	1	2	3	4	5	6	7	8	9	10	11	12	13	14	15	16
SW1	1	0	1	0	1	0	1	0	1	0	1	0	1	0	1	0
SW2	1	1	0	0	1	1	0	0	1	1	0	0	1	1	0	0
SW3	1	1	1	1	0	0	0	0	1	1	1	1	0	0	0	0
SW4	1	1	1	1	1	1	1	1	0	0	0	0	0	0	0	0

Fig. 4.3

Address "1" is the factory setting of PD22.

If the PD22 is one of several filling stations in a system, none of the stations may have the same address and it must therefore be changed.

Change of address is performed via a dip-switch placed at the bottom of the PD22. This change may only be carried out when the machine is turned off at the main power switch.

Addresses between 1 and 16 may be chosen, and Fig. 4.3 shows the various combinations.

5 Control

5.1 Dispenser head

The dispenser head can work with different tube diameters.

The dispenser head works with two parallel tubes which are squeezed by six rollers mounted on ball bearings. The rollers in the two sections are offset in order to eliminate pulsing.

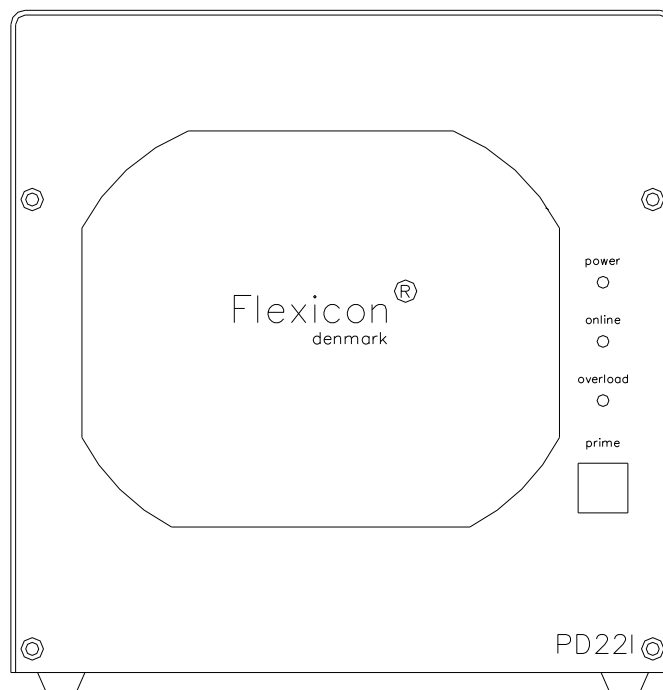

Fig. 5.1

- Power** Lights when the machine is on.
- Online** Lights when communicating with MC12.
- Overload** Lights when the PD22 is overloaded.
- Prime** Pushbutton for tube priming.

6 Dispensing with PD22

For optimal dispensing with the PD22, the following should be observed:

6.1 Vessel Placement

In order to build up adequate pressure and reduce friction, it is recommendable to place the vessel containing fill media at the same level as pump head or preferably above the pump head level. Placing the vessel higher than pump head level provides positive product support and may reduce the calibration interval. It is also recommended to place the vessel as close as possible to the pump on suction side.

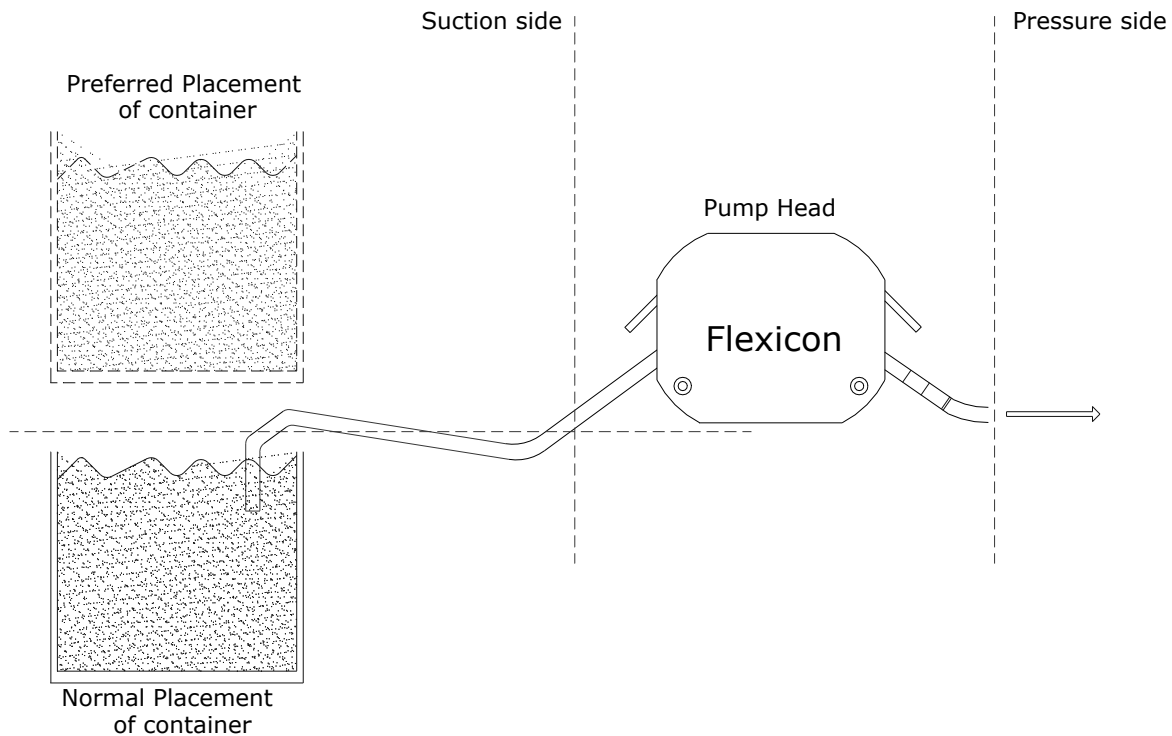

Fig. 6.1

6.2 Tube size

Tubes must be selected according to the application and volume to be filled.

PD22 can operate with different tube dimensions chosen according to the volume to be dispensed.

The tubes are designated by their internal diameters (i.d.) in millimetres. This value is always used as designation for the individual tube, and this is also the value to be entered in function 2 at the MC12 master controller.

PD22 can operate with the filling nozzles, tubing and Y-connectors listed in the table below. In order to obtain stable and good filling accuracy, the choice of tubing may be made according to the following guidelines:

Min. Volume recommended	Tubing Inside diameter	Y-connector Outside diameter
10 ml	3.0 mm i.d.	4 mm o.d.
20 ml	5.0 mm i.d.	6 mm o.d.
50 ml	6.5 mm i.d.	8 mm o.d.
85 ml	8.0 mm i.d.	10 mm o.d.
150 ml	10.0 mm i.d.	12 mm o.d.
250 ml	12.5 mm i.d.	14 mm o.d.

Fig. 6.2

Above mentioned tubes are silicone tubes and supplied by Watson-Marlow Flexicon A/S.

These can be sterilised by autoclaving, gamma radiation or ethylene oxide.

It is recommendable that the tubes are of such length that can allow placing the vessel close to the pump head.

The tube ends must always be kept below the liquid level of the suction vessel in order to keep the tubes from sucking air.

Avoid having tubes close to the bottom of product vessel.

6.3 Nature of fill media

The peristaltic dispensers are not suitable for viscous products. For viscous product another type of dispenser from WM Flexicon can be used. In the case that the PD22 should be used and the product is of viscous nature, then heating the product before dispensing with PD22 is recommended.

Another consideration is the surface tension of liquid. Product with high surface tension tends to produce drip. Due to this fact it is difficult to have sufficient cut off after every individual dispense. When filling with small volumes and high surface tension present drips are often produced and constitute inaccuracy.

6.4 Priming tubes

In order to evacuate air from the tubes and prepare the tubes for filling, it is necessary to prime the tubes. Priming must be done adequately and continued until the tube material hysteresis disappears as well as any air bubbles.

6.5 Drip

When dispensing very small volumes, the last drop of the filling constitutes a big part of the total filling.

For small volumes a dumping nozzle system can be applied to control the last drop of filling.

When dispensing with very large volumes, the shape of nozzle and the filling speed required may not always be compatible.

For this reason consideration should be done if using non-return valve or forced back-suction is necessary.

Flexicon dispensers offer back-suction (reversing) after every individual dispensing.

6.6 Hard Feed

When dispensing with small tubes, counter pressure on the pressure side of pump head might constitute inaccuracy and instability in filling (hard feed). In some cases the problem can be resolved by using a larger tube on the pressure side (after Y-connector).

7 Tube assembly

7.1 Assembly of Y-connectors

Since the dispenser head of PD22 is fitted with a double rotor, two suction tubes are used all the way through the dispenser head. These two suction tubes are joined by a Y-connector just behind the dispenser head.

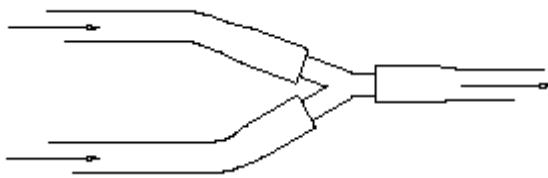

Fig. 7.1

The chosen tube is joined by a Y-connector as shown in Fig. 7.1.

7.2 Placing tubes in the pump head

After selecting a suitable tube diameter and after fitting the tubes with Y-connector and filling needle, mount the tubes in the dispenser head.

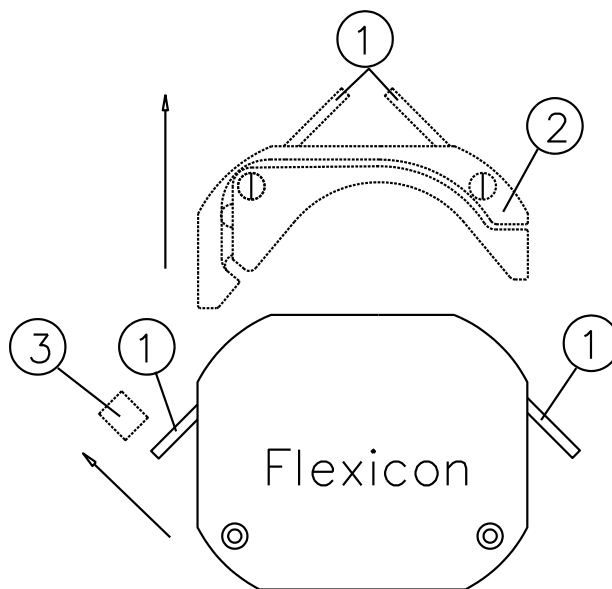

Fig. 7.2

Open the dispenser head by turning the two locking pins (1) over the tube bridge (2), after which the tube bridge can be lifted up.

It will now be possible to remove the tube lock (3) from its dowel pin.

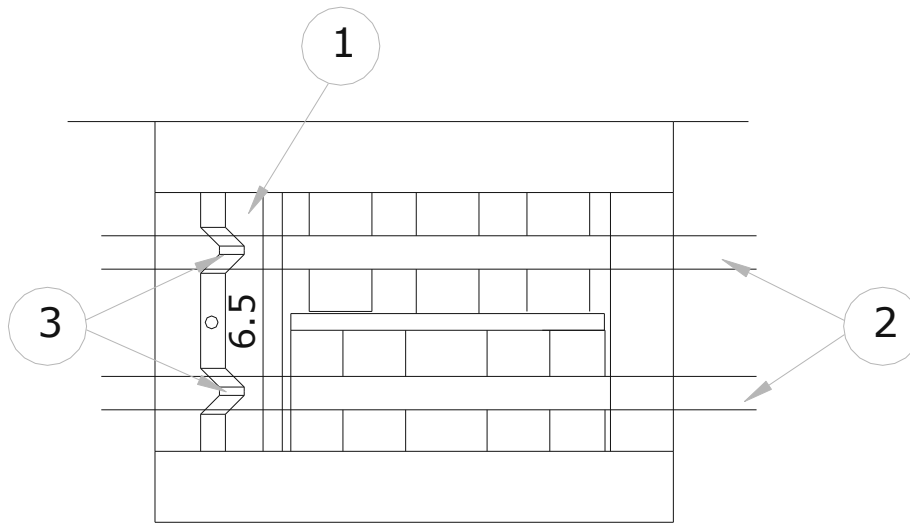

Fig. 7.3

Mount the correct tube lock (1) on its dowel pin and place the tubes (2) in the dispenser head. The Y-connector must be situated to the right of the dispenser head.

It is important that the tubes are situated in the two notches (3).
Now place the tube bridge in its tracks and engage the two locking pins.

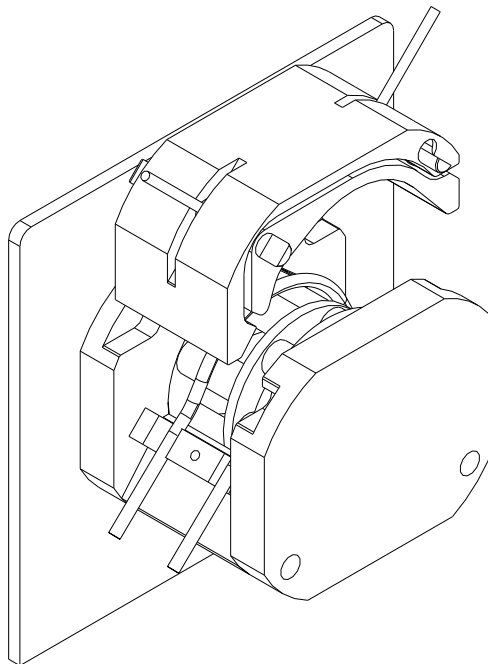

Fig. 7.4

The tube ends must always be kept below the liquid level of the suction vessel in order to keep the tubes from sucking air.

*NB! Never leave the dispenser mounted with tubes overnight.
At least tip the locking pins up in order not to retain the tube in pressure.*

8 Programming

8.1 Programming principle

In the following, a parameter will be the value of a single function, i.e. volume, tube diameter or velocity. A program will be a complete set of parameters which together will constitute the PD22 work instructions.

The actual programming will be made on the MC12 and reference is made to the MC12 manual.

8.2 PD22 parameters

1. Volume

Value: ml

Range: 10 - 9999 ml

PD22 can dispense from 10 to 9999 ml, but for volumes exceeding approx. 1000 ml, the capacity will drop significantly.

If the volume is changed, a recalibration should be made.

2. Tubes

Value: Inside diameter (i.d.) in mm

Range: 3.0 - 5.0 - 6.5 - 8.5 - 10.0 - 12.5

If the tube is changed, a new calibration must always be made.

3. Velocity

Value: Revolutions per minute (rpm)

Range: 30 - 250 rpm

If the velocity is changed, a recalibration should be made.

4. Acceleration/deceleration

Value: An integral number

Range: 1 - 100

The acceleration and the deceleration will always be the same. The lowest value (1) will give the slowest acceleration, and the highest value (100) will give the fastest acceleration.

If the acceleration is changed, a recalibration should be made.

5. Reversing (back suction)

Value: An integral number

Range: 0 - 10

If the rotor is moved a little backwards (reversing) after the completion of fillings, a minor back suction will be created. This can prevent dripping from the filling needle.

The value "0" will give no reversing, but the value "10" will give maximum reversing.

ALWAYS make a recalibration if the reversing value is altered.

For other programming possibilities, reference is made to the MC12 manual.

9 Cleaning and maintenance

9.1 Daily cleaning

As PD22 is not in direct contact with the dispensed product, daily cleaning will not be necessary except for the normal routine cleaning of production equipment.

Liquids must NOT be splashed onto the PD22.

It may only be cleaned with a damp paper towel or a firmly wrung cloth.

The cabinet is made of stainless steel and anodized aluminium, and normal cleaning agents such as tepid/medium hot water, ethyl alcohol (ethanol) 70% may be used all over the machine.

9.2 Sterilization

If PD22 is placed in an aseptic environment, the sterilization may be made as described in section 9.1, or you may sterilize PD22 by gases observing the following precautions.

If you use gases that might injure and corrode contacts and other metals, air slots and sockets MUST be covered with tape.

9.3 Maintenance

As all movable parts in PD22 are maintenance-free, no maintenance is required apart from normal cleaning of the equipment.

Should service be needed, please contact WM Flexicon A/S or your supplier.

10 Interface and change of voltage

10.1 PD22 I Interface

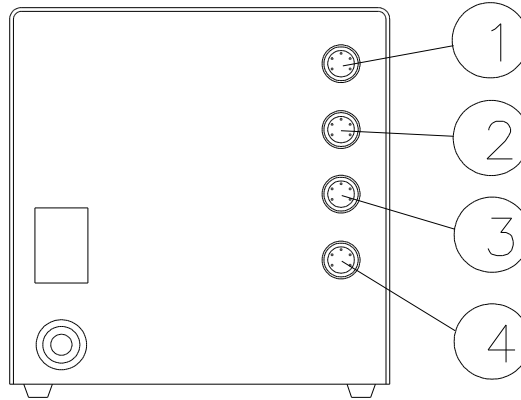

Fig. 10.1

(1) External 1:	
PIN 1:	INPUT FOR START SIGNAL +5 - 50 VDC, min. 100 msec. positive-edge-triggered.
PIN 2:	OUTPUT, +24 VDC, MAX. 500 MA.
PIN 3:	GROUND.
PIN 4:	STATUS OUTPUT, MAX. +24 VDC, 100 mA. Pin 4 is grounded via an open collector during filling.
PIN 5:	STATUS OUTPUT, MAX. +24VDC, 100 mA Pin 5 is complementary to pin 4.
(2) External 2:	
PIN 1:	INPUT FOR DISABLING. +5 - 50 VDC. if this pin is activated, the drive will be disabled (no dispensing).
PIN 2:	OUTPUT, +24 VDC, MAX. 500 MA.
PIN 3:	GROUND.
PIN 4:	STATUS OUTPUT, MAX. +24 VDC, 100 MA. Pin 4 is grounded via an open collector during filling.
PIN 5:	STATUS OUTPUT, MAX. + 24 VDC, 100 MA. Pin 5 is complementary to pin 4.
(3) Net 1	This socket is reserved for (RS-485) network communication.
(4) Net 2	This socket is reserved for (RS-485) network communication.

Tab. 10.1

10.2 PD22 P Interface

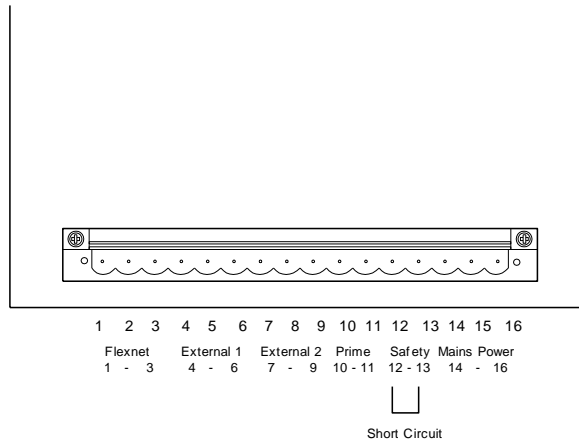

Fig. 10.2

(1) Flexnet 1-3:	
pin 1.	Flexnet /data (pin 1 on flexnet DIN connector)
pin 2.	Flexnet gnd (pin 3 on flexnet DIN connector)
pin 3.	Flexnet data. (pin 4 on flexnet DIN connector)
(2) External 4-9:	
pin 4.	Start signal. +5 to +50 Vdc. Positive edge triggered.
pin 5.	+24 Vdc output
pin 6.	Ground
pin 7.	Status output signal. Open collector. Grounded when drive is active
pin 8.	Status output signal. Open collector. Grounded when drive is not active
pin 9.	Disable signal. +5 to +50 Vdc. Dispensing disabled when active.
(3) Prime 10-11:	
pin 10.	Prime (ground)
pin 11.	/Prime (drive priming when connected to ground)
(4) Safety 12-13:	
pin 12.	Safety 1, short circuit, prepared for external safety device or safety input from pin 13.
pin 13.	Safety 2, (24 Vdc output)
(5) Main power 14-16:	
pin 14.	Main supply. Neutral
pin 15.	Main supply. Earth
pin 16.	Main supply. Line

Tab. 10.2

11 Declaration of conformity

We **Watson-Marlow Flexicon**
Frejasvej 2-6
DK-4100 Ringsted

Declare on our sole responsibility that the peristaltic dispensers:

Peristaltic Dispenser	Item Number
PF6	91-050-008
PF22	91-220-000
PD12I	91-150-014; 91-150-020
PD12IHS	91-150-300
PD12P	91-151-014
PD12PS	91-152-014; 91-152-020
PD22I	91-250-022
PD22P	91-251-022
PD22PS	91-252-022

To which this declaration relates is in conformity with the following standard(s):

- EN61000-6-2:2005 Electromagnetic compatibility (EMC) - Part 6-2: Generic standards - Immunity for industrial environments
- EN61000-6-3:2007 Electromagnetic compatibility (EMC) - Part 6-3: Generic standards - Emission standard for residential, commercial and light-industrial environments

According to the provisions in the Directives:

- 2006/42/EC On the approximation of the laws of the Member States relating to machinery
- 2014/30/EU On the harmonisation of the laws of the Member States relating to electromagnetic compatibility
- 2014/35/EU On the harmonisation of the laws of the Member States relating to the making available on the market of electrical equipment designed for use within certain voltage limits

Signature:

April 2021

Ringsted, Denmark



Jørn Jeppesen, Senior Specialist, Compliance & Development